

Email: ipf\_dependables@rediffmail.com  
Website: www.dependablesfasteners.com

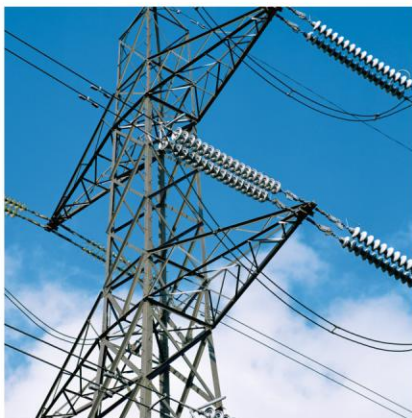

# DEPENDABLES

AN ISO 9001:2015 CERTIFIED COMPANY

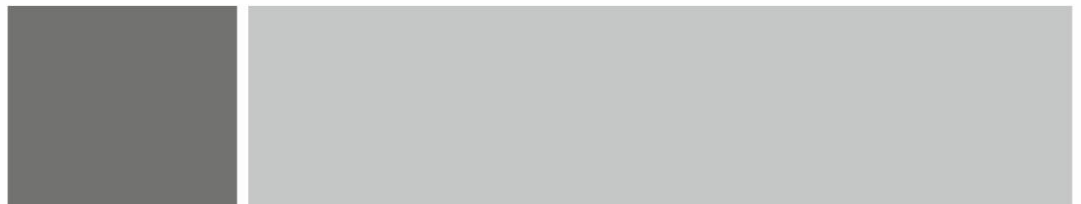

*“Committed to quality, service & value!”*

Manufacturers & Suppliers of:  
INDUSTRIAL PRECISION FASTENERS

High Tensile Fasteners | Special Fasteners as per Drawings | All kinds of Industrial Nuts, Bolts & Washers



**DEPENDABLES**

AN ISO 9001:2015 CERTIFIED COMPANY



Office Block & Ware House

## Introduction

**DEPENDABLES FASTENERS** are engineered to precision, accuracy and perfection. Their performance is testimony of their durability and adherence to the international standards. By virtue of our established manufacturing organization, technical skills and through professionalism in all fields. Our patrons have recognized us out rightly.

Dependable Fasteners is established by Mr. S.K. Sareen with the 38 year's experience, to serve the fasteners industries with its quality products especially, All kinds of Industrial Fasteners & High Tensile Fasteners.

The Company is serving the highly reputed exporters and supplier's .The company is not only having its products in the local market but also exporting to various developing and advanced countries. The Company is benefited much because of the highly professional and customer oriented approach of Mr. S.K. Sareen. The Company is achieving new heights under the dynamic leadership of all team of Dependable Fasteners, This is only because their understanding and in-depth experience in the Fasteners industry and others that today Dependable Fasteners stands for Quality Perfection Precision and durability, It's brand name **IPF** have become synonymous to perfection not only in the local Indian market but as well as in the abroad.

## Director's Desk



Mr. S.K. Sareen

The Managing Director Mr. S.K. Sareen himself is having more than 45 Year's practical experience in this field and resulted the international export quality comes out as a final product from our company to satisfy the customers years and years.

I feel Proud to say that "DEPENDABLES" has always given more than the expected results and to support the increasing customers demand. Latest technology is being regularly upgraded through R & D department.

## Our Mission

Dependables (Fasteners Unit) is committed to providing its customers products with a very competitive relation between price/quality, guaranteeing high levels of customer service, by means of a group of trained and motivated employees who assure the satisfaction of our clients. To make you count on us.

## Journey To Excellence

Excellence is earned through hard work and dedication to manufacture world class quality product. At **DEPENDABLES**, we live by these words everyday.

Since 1976, we have been committed to manufacture the best Industrial Precision Fasteners. This ongoing commitment doesn't stop with the manufacturing process itself. We strongly believe that the real attributes of a great company are to treat every customer with utmost respect and satisfy their every need the first time and every time. Our Customers appreciate this dedication to Total Customer Satisfaction and have rewarded us with Strong term Relationships.

To build strong relationships, one has to firstly gain respect in the eyes of its customers. Most of the respect we have attained comes from our long term commitment to quality.

This dedication has allowed us to deliver the height quality products on a timely basis and at a fair price. This journey doesn't end here, we will continue to search for a new ways to improve, to deliver higher quality products to our reputed valued customers and most importantly, maintain the highest ethics in our pursuit of Excellence.



**DEPENDABLES**

AN ISO 9001:2015 CERTIFIED COMPANY

# Certifications



AN ISO 9001:2015 CERTIFIED COMPANY



Manufacturing Certificate



FASTENERS MANUFACTURERS ASSOCIATION OF INDIA

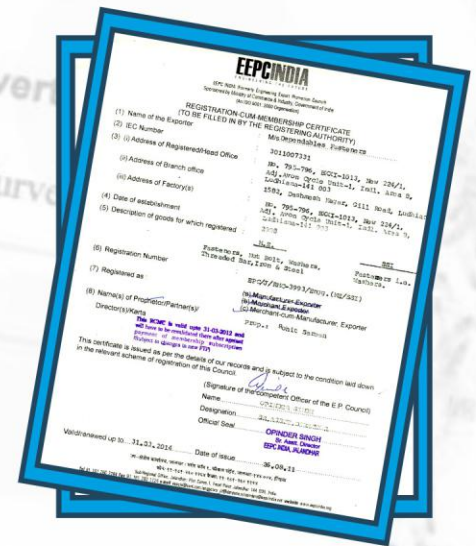

EEPC INDIA

## Distribution Network

Canada



Europe



Italy



N.B. In case any technical information about the products is required you may contact our head office at Ludhiana . However you may contact our local representative with regard to your queries relating to price , availability of material , delivery schedules etc.



**DEPENDABLES**  
AN ISO 9001:2015 CERTIFIED COMPANY



## Design & Development

In-house facilities for design using latest designing softwares result in fast development & delivery quality Industrial Precision Fasteners.

Our tool room designs and develops Dies, Fixtures and Special Purpose Machine Tools in-house which helps to reduce product cost and maintain better quality product.

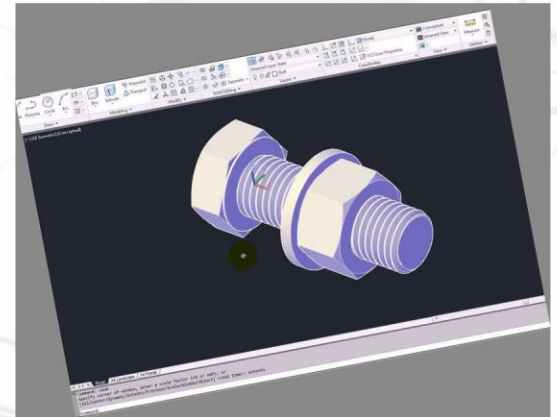

## Manufacturing Facilities

As a manufacturing company, over the years we have many capacities, built up technologies and invested in equipments which helps to become a "One Stop Shop for Industrial Precision Fasteners".

- » Cold Forging Facility
- » Hot Forging Facility
- » Bar Drawing Facility
- » Heat Treatment Facility
  - Carburising
  - Hardening
  - Tempering
  - Annealing
- » Induction Hardening
- » Machining Facility
  - CNC / VMC Turning Centers
  - SPM's / Turning Block
- » Surface Treatment
  - Phosphating
  - Auto Black
  - Zinc Electro - Plating
  - Powder Coating
- » Tool Room
- » Testing Facility
  - Chemical
  - Physical
  - Structural Analysis
- » Metallurgical Laboratory

# Manufacturing Facilities



We have in house facility for plating like :  
Hot dip Galvanize , Cadmium, Electro - Galvanize -Golden/Zinc/Green plated,  
Mechanical Galvanize , Copper plating, Black ETC



DEPENDABLES  
AN ISO 9001:2015 CERTIFIED COMPANY



## Product Range

## Nuts

### Nuts

#### Diameters:

2MM to 100MM or 3/16" to 4"

#### Stock Range:

- Cage Square Nuts
- Castle Hex Nuts
  - Thick Castle Nuts
  - Thin Castle Nuts
- Collar Nuts
- Crimp Nuts
  - Flange Crimp Nuts Two Side ( Hot Forge )
  - Flange Crimp Nuts Three Side
  - Turned Crimp
- Cup / Close Nuts
- Dome Nuts
- Eye Nuts
- Flange Hex Nuts
- Full Hex Nuts
  - Turned
  - Cold Forge
- Lock Hex Nuts
- Locking Counter Nuts ( Press )
- Long Nuts
- Pinion Hex Nuts
- Press Mix Nuts
- Prevailing Torque Nuts
- Rectangular Nuts
- Round Nuts
- Self Locking Hex Nuts
  - Flange ( Nylon Insert )
  - Flange ( Metal Insert )
- Sheering Nuts / Anti Theft Nuts
- Slotted Nuts ( Hex / Round )
- Spring Nuts
- Square Nuts
- T Nuts
- Weld Nuts
- Wheel Hex Nuts
- Wing Nuts / Wedge Nut
  - Press / Casting / Forging
- Flange Dome Nuts
  - Single / Two Pieces
- Nylon Nuts
- Hex Nuts ( Washer Face )
- Special Nuts

#### Grades:

Nuts are made of Grade 4, 5, 6, 8, 2H

other Grades also available as per customer requirement

#### Finish / Colours:

Hot Dip Galvanized ( HDG)

Zinc Plated

Yellow Plated

Self / Black / Natural

Mechanical Galvanized







## Nuts



Cage Nuts



Hex

Round

Hex Slotted Nuts



Hex Castle Nuts



Hex Flange Slotted Nuts



Check Nuts



Collar Nuts



Flange Nuts



T Nuts



Cap / Close Nuts



Dome Nuts



Flange Dome Nuts



Eye Nuts



**DEPENDABLES**  
AN ISO 9001:2015 CERTIFIED COMPANY



## Product Range

## Nuts



2H Heavy / Full Nuts



Hex Lock Nuts

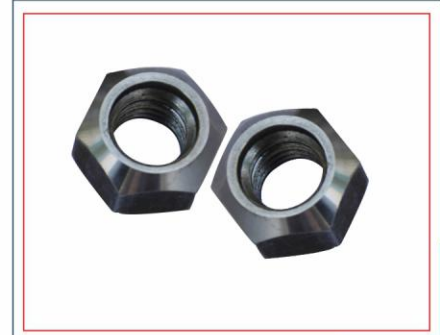

Prevailing Torque Nuts



Hex Nuts Washer Face



Locking Counter Nuts



Locking Nuts



Turned Crimp Nuts



Crimp Nuts (Turned)



Crimp Nuts (Knurling Turned)



Crimp Flange Nuts (Three Side)



Crimp Flange Nuts (Two Side)

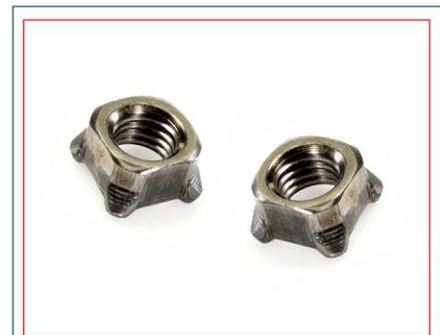

Square Weld Nuts



## Nuts



Hex Weld Nuts



Long / Coupling Nuts

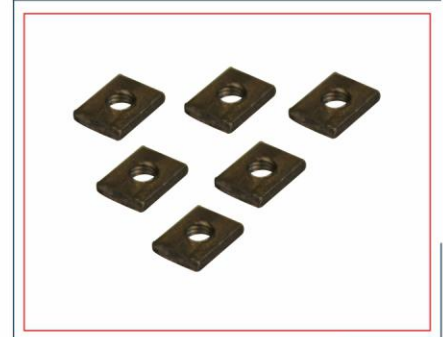

Rectangular Nuts



Square Nuts



Wheel Nuts



Wing Nuts (Forgings)



Hex Wing Nuts



Wing Nut Rubber Moulding



Wing Nuts (Castings)



Wing Nuts (Press)



Riveting Nuts



Round Nuts



**DEPENDABLES**  
AN ISO 9001:2015 CERTIFIED COMPANY



## Product Range

## Nuts



Hex Pinion Nuts



Anti Theft / Sheering Nuts



Spring Nuts



Nylock Insert Nuts



S/L Flange Nuts (Metal Insert)



S/L Flange Nuts (Nylone Insert)



Hex Full S/L Nuts (Metal Insert)



Nylone Nuts



Some of our Special Nuts



## Washers

### Stock Range:

- Conical Washers
- Cut Type Washers
- Disk Washers
- Fan Disk Washers
- Friction Grip Washers
- Heavy Washers
- Machine Washers
- Multi Tooth Lock Serrated Washers
  - Internal Teeth
  - External Teeth
  - Combine Teeth
  - Over Lapping
- Pack Washers
- Plain Whole Circular Washers
- Punched Round Washers
  - Fiber
  - Nylon
  - Aluminium
- Push Button Washers
- Round Washers for Self Locking Nuts
- Semi Machine Washers
- Shim Washers - Spring Steel
- Spring Washers
  - Square Section / Flat Section
  - Serrated / Plain
- Square Washers
- Tab Washers
- Tapper Washers
- Wave Washers

### Finish / Colours:

Hot Dip Galvanized ( HDG)  
Zinc Plated  
Yellow Plated  
Self / Black / Natural  
Mechanical Galvanized

## Washers





**DEPENDABLES**  
AN ISO 9001:2015 CERTIFIED COMPANY



## Product Range

## Washers



Conical Washers



Heavy Washers

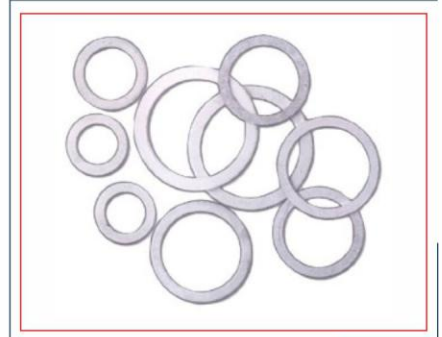

Shim / Pack Washers



Plain Whole Circular Washers



Circlip Washers



Disc Washers



Fan Disc Washers



E/T Multi Tooth Lock Washers



I/T Multi Tooth Lock Washers



Friction Grip Washers



Wave Washers



Taper Washers



# Washers



Tab Washers

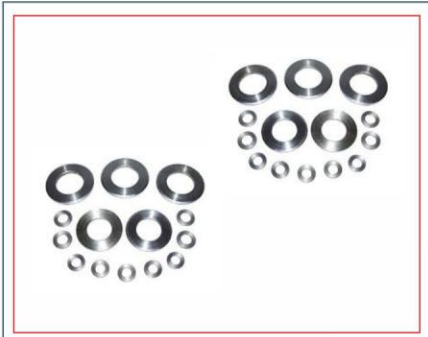

Machine Washers



Semi Machine Washers

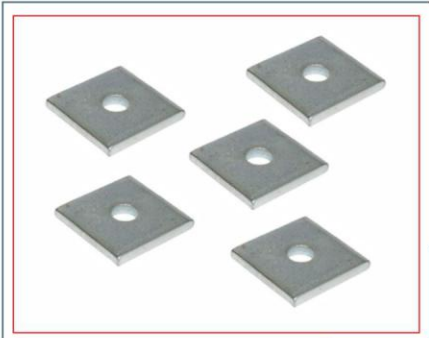

Square Washers



Push Button Washers



Spring Washers



Cut Type Washers

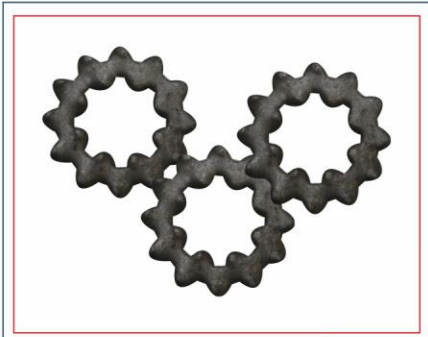

Combine Teeth Washers



Serrated Spring Washers



Serrated Punch Washers



Fibber Washers



Nylone Washers



**DEPENDABLES**  
AN ISO 9001:2015 CERTIFIED COMPANY



## Product Range

## Bolts & Screws

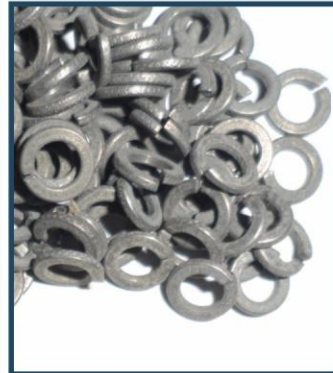
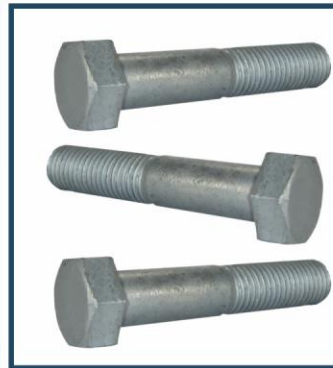

## Bolts

**Diameters:**  
5MM to 100MM or 3/16" to 4"

**Threads:**  
MM, BSW, BSF, UNC, UNF, UN, NC

**Grades:**  
Bolts are made of Grade 4.6, 4.8, 5.6, 5.8, 6.8, 8.8  
Other Special Grades are available as per customer requirement

**Finish / Colours:**  
Hot Dip Galvanized ( HDG)  
Zinc Plated  
Yellow Plated  
Self / Black / Natural  
Mechanical Galvanized





## Stock Range:

- Allen Counter Sunk Head Screws
- Allen Socket Head Cap Screws
- Benjo Bolts
- Bucket Bolts
- Carriage Bolts
- Center Bolts
- Cheese Head Bolts
- Coach Bolts
- Collar Bolts
- Counter Shank Bolts
  - Allen Type
  - Philips Type
  - Slotted Head Type
- Counter Shank Square Neck Bolts
- D Head Bolts
- Eye Bolts
- Fish Bolts ( Cup Oval Neck Bolts )
- Foundation Bolts
- Friction Grip Bolts
- Hammer Bolts
- Hex Bolt Screws
- Hex Flange Bolts
- Hub Bolts
- J Bolts
- L bolts
- Eye / Lifting Eye Bolts
- Mix Bolt Fasteners
- Nib Bolts
  - CSK
  - Round Head
- Pan Head Bolts
  - Philips
  - Slotted Head
- Rack Bolts
- Slotted Round Head Bolts
- Self Taping Screws
- Socket Button Head Cap Screws
- Socket Counter Sunk Head Screws Allen
- Hammer Bolts

## Bolts & Screws

- Special Drill Process
- Square Head Bolts
  - CSK
  - Flat Neck
- Step Bolts
- T Bolts ( Flat & Round Head )
- Nylone Bolts
- Grub Screws
  - Allen
  - Slotted
- Track Show Bolts





**DEPENDABLES**  
AN ISO 9001:2015 CERTIFIED COMPANY



## Product Range

## Bolts & Screws



Flange Bolts



Hex Plug



Collar Flange Bolts



Collar Bolts



Foundation Bolts



Friction Grip Bolts



Rack Bolts



Rectangular Head Bolts



Square Head Bolts



Slotted Round Head Bolts



Slotted Cheese Head Screws



Slotted CSK Head Screws



## Bolts & Screws



Slotted Pan Head Bolts



Slotted Grub Screws



Allen Grub Screws



Hex Bolts



Hex Coach Bolts



Coach Screws



Hub Bolts



J Bolts



Step Bolts



U Bolts



L Bolts



Weld Bolts



**DEPENDABLES**  
AN ISO 9001:2015 CERTIFIED COMPANY



## Product Range

## Bolts & Screws



CSK

Round

Nib Bolts



Philips Pan Head Screw



Self Taping / Wood Screws



Wing Screws



Fish Bolts



Socket Button Head Screws



Allen CSK Head Screws



CSK Bolts



Square Head Bolt CSK Neck



Slotted Head Cap Screws

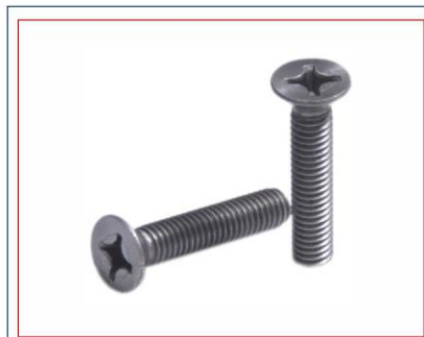

Counter Sunk Philips Head Screws



Banjo Bolts



## Bolts & Screws



Bucket Bolts



Hammer Head Bolts



Carriage Bolts



Center Bolts



Counter Shank Square Neck Bolts



Nylone Bolts



Eye Bolts



Eye Lifting Bolts



D Bolts



Flat T Head Bolt



Round T Head Bolt



Track Shoe Bolts



**DEPENDABLES**  
AN ISO 9001:2015 CERTIFIED COMPANY



## Product Range

## Scaffolding & Other Products



Bottom & Top Cups



Cup Nut



Prop Nuts



Jack Nut



Pipe



Split Pins



Swivel & Right Angle Coupler



Rivets



Flanges



Thread Bar



Studs / D Studs



Allen Wrenches



## Scaffolding & Other Products



Rawl Bolts



Zebra Pin Type



Projection Bolts

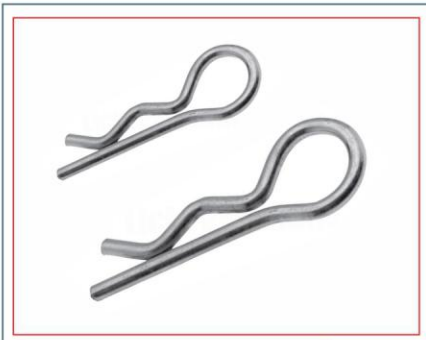

R Spring



L hooks



D Hooks



Bushes



Linch Pin



Hinges



Press Components





**DEPENDABLES**  
AN ISO 9001:2015 CERTIFIED COMPANY



## Product Range

## Special Fasteners







### Special Fasteners





**DEPENDABLES**  
AN ISO 9001:2015 CERTIFIED COMPANY



## Product Range

## Special Fasteners





# Special Fasteners

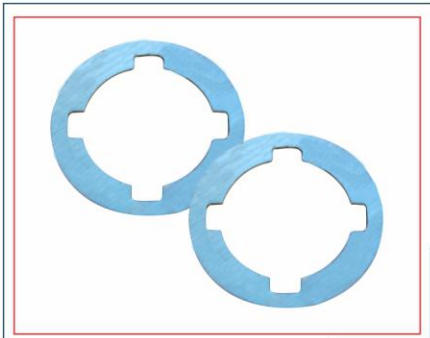



**DEPENDABLES**  
AN ISO 9001:2015 CERTIFIED COMPANY



## Special Fasteners





# Special Fasteners

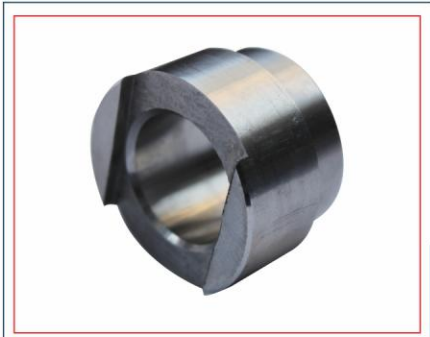



**DEPENDABLES**  
AN ISO 9001:2015 CERTIFIED COMPANY



## Manufacturing Facilities

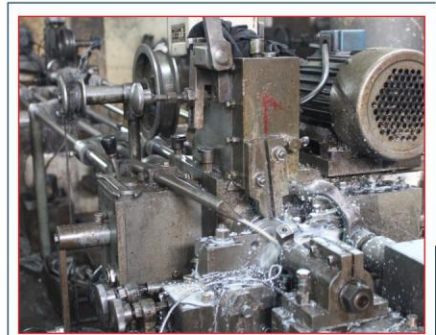
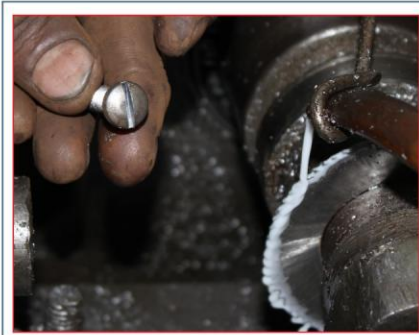



### Testing Facilities



Rockwell Hardness Testing Machine



Caliper Gauge



Gauges

### Inspection & Packaging Facilities





<https://www.facebook.com/DependablesFasteners>



<https://in.linkedin.com/in/dependablesfasteners>



<https://twitter.com/DEPENDABLESFAST>



dependables.ludhiana



**DEPENDABLES**

AN ISO 9001:2015 CERTIFIED COMPANY

Note: kindly forward your post at Corporate Address

**Corporate Office**

Plot 1592, Lane No. 11, Dashmesh Nagar,  
Gill Road, Ludhiana - 141003, Punjab (INDIA)  
Mobile: +91-98884-95196, 98884-95197  
Email: [idf\\_dependables@rediffmail.com](mailto:idf_dependables@rediffmail.com)  
Website: [www.dependablesfasteners.com](http://www.dependablesfasteners.com)

**Works**

Plot 795, Industrial Area-B, Gill Road,  
Ludhiana - 141003, Punjab (INDIA))